

6

5

4

3

2

1

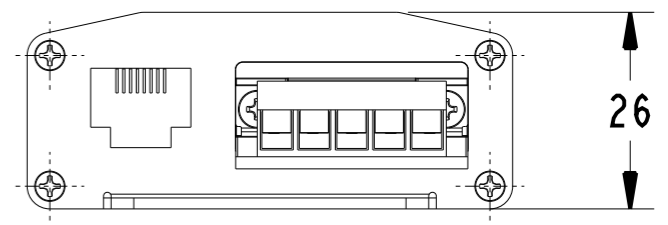
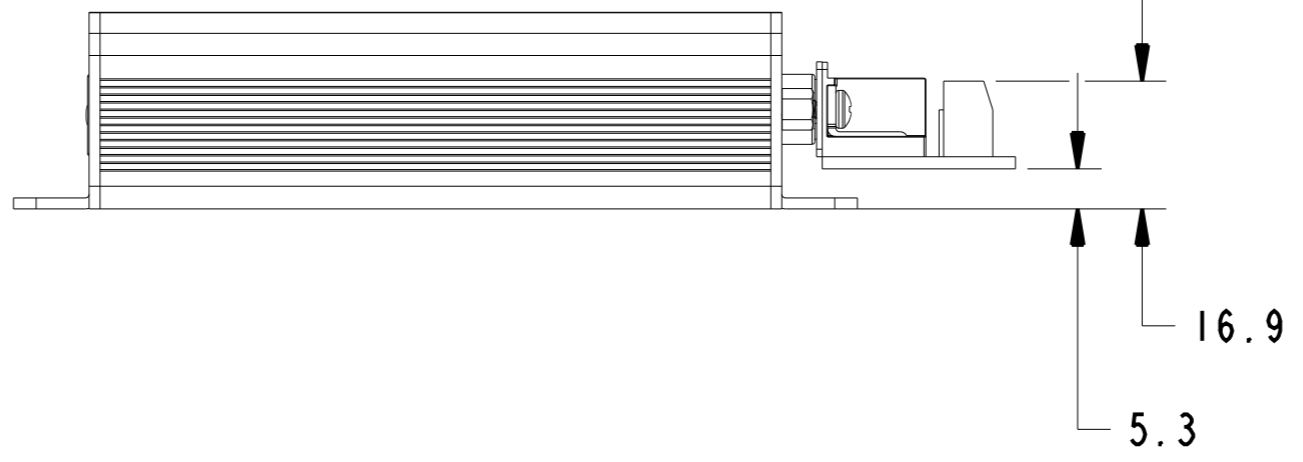
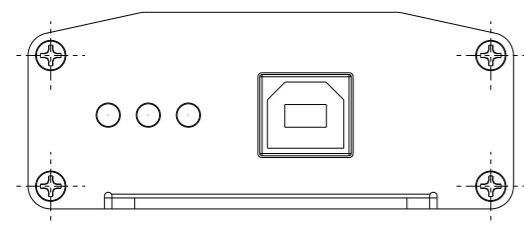
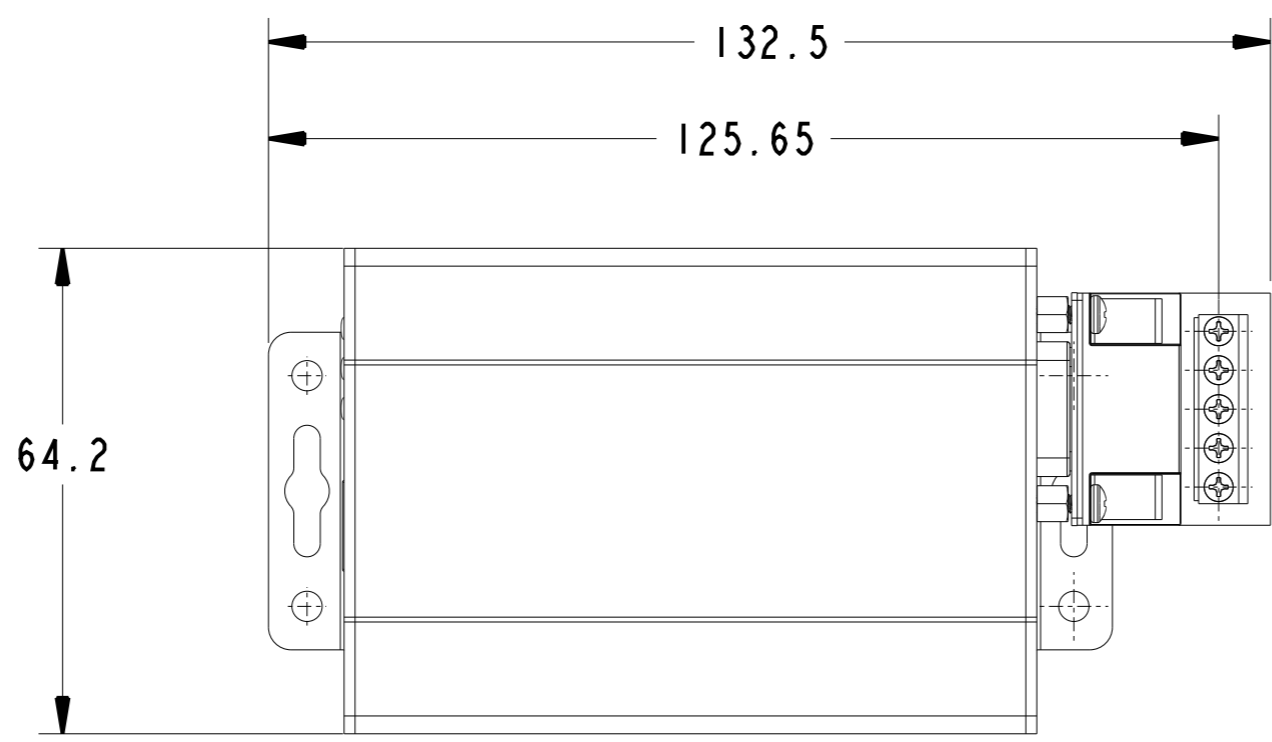

**Serial Comm**®  
Data Conversion Experts

MODEL :	USB - ISO - 485		
DESCRIPTION :	USB TO RS485/RS422 (5 POSITION TERMINAL BLOCK)		
SCALE :	1 : 1	UNIT :	mm
ISSUE DATE :	07/22/2023	REV. NO. :	1.2

6

5

4

3

2

1

6

5

4

3

2

1

D

D

Ø4 4 PLACES

30.5

13.9

101.4

42

Ø5.9 2 PLACES

3.5 2 PLACES

C

C

91.6

25

8.78

13.17

B

B

64.2

111.6

A

A

**Serial Comm**®  
Data Conversion Experts

MODEL :	USB-ISO-485		
DESCRIPTION:	USB TO RS485/RS422 (NO TERMINAL BLOCK)		
SCALE:	1:1	UNIT:	mm
ISSUE DATE:	07/22/2023	REV. NO.:	1.2

6

5

4

3

2

1

6

5

4

3

2

1

D

C

B

A

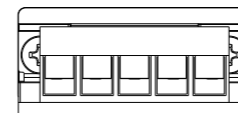
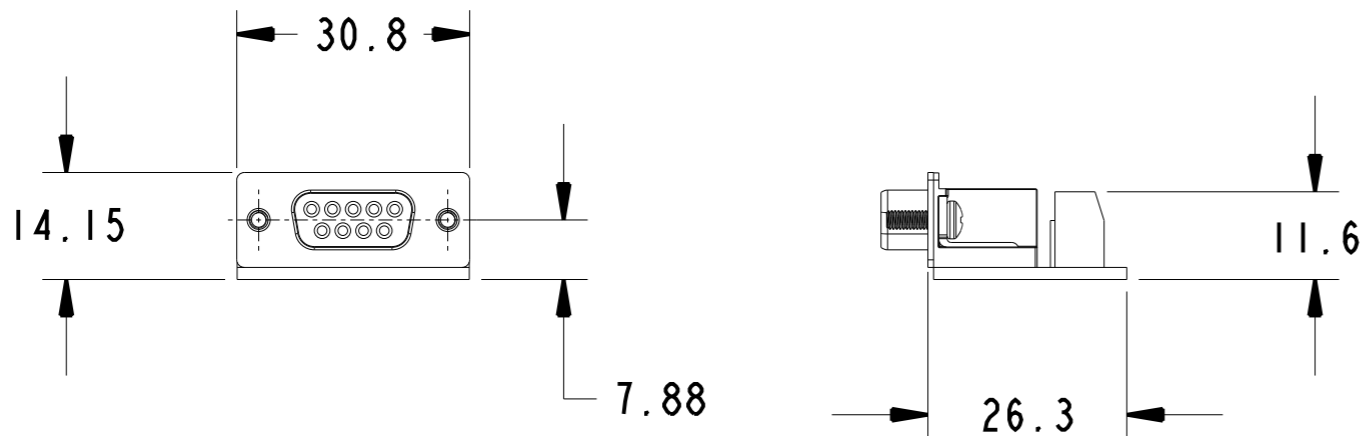
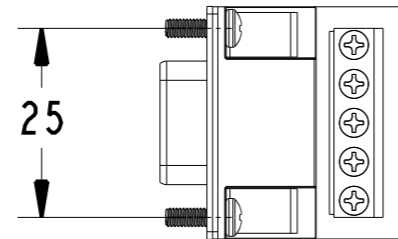

**Serial Comm**®  
Data Conversion Experts

MODEL :	USB-ISO-485		
DESCRIPTION :	5 POSITION TERMINAL BLOCK		
SCALE :	1 : 1	UNIT :	mm
ISSUE DATE :	07/22/2023	REV. NO. :	1.2

6

5

4

3

2

1